

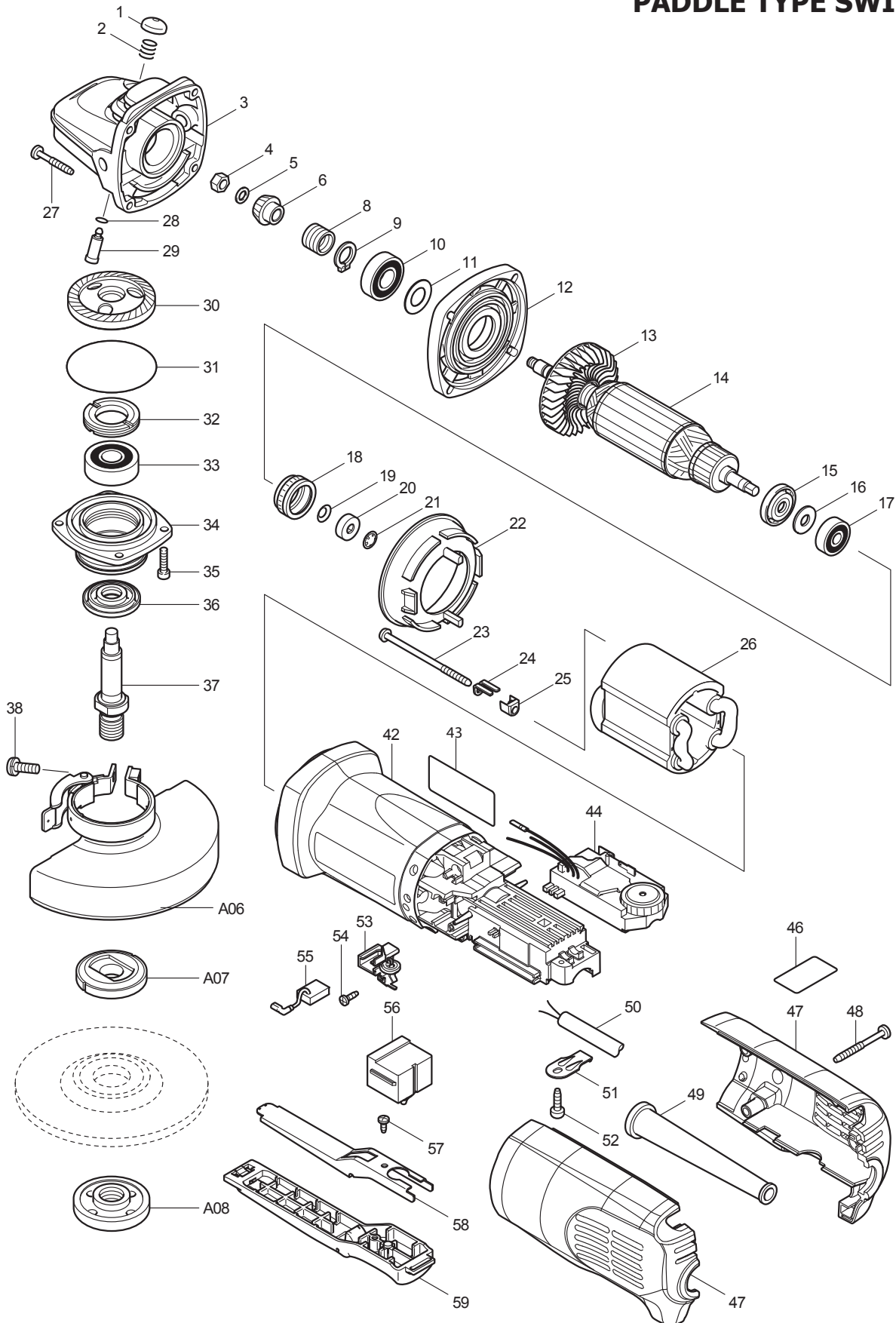

12 - 2010  
9564PCV  
4-1/2" GRINDER  
PADDLE TYPE SWITCH



Item No	Type	Ref	Part No	Description	Qty	Unit
001			418067-8	PIN CAP	1	PC.
002			233072-2	COMPRESSION SPRING 8	1	PC.
003			153488-4	GEAR HOUSING COMPLETE	1	PC.
		INC.	211021-9	BALL BEARING 607LLB	1	PC.
004			931303-0	HEX. NUT M6	1	PC.
005			253077-6	FLAT WASHER 6	1	PC.
006			227513-8	SPIRAL BEVEL GEAR 11	1	PC.
008			233901-9	LOCK SPRING 12	1	PC.
009			961052-5	RETAINING RING S-12	1	PC.
010			210105-0	BALL BEARING 6001LLU	1	PC.
011			253084-9	FLAT WASHER 12	1	PC.
012			317359-1	GEAR HOUSING COVER	1	PC.
013			240033-5	FAN 57	1	PC.
014	3		518160-9	ARMATURE ASS'Y 115V	1	PC.
		INC.		Item No. 13,15-17		
015			681656-4	INSULATION WASHER	1	PC.
016			253823-7	FLAT WASHER 7	1	PC.
017			210027-4	BALL BEARING 627DDW	1	PC.
018	1		421738-8	LABYRINTH RUBBER RING 22	1	PC.
	2		422750-1	LABYRINTH RUBBER RING 22	1	PC.
019			267756-0	WAVE WASHER 6	1	PC.
020			688117-5	MAGNET SLEEVE	1	PC.
021			259039-2	SELF LOCK 6	1	PC.
022			413076-2	BAFFLE PLATE	1	PC.
023			266258-3	TAPPING SCREW 4X70	2	PC.
024			344871-8	RETAINER	2	PC.
025			417237-6	INSULATION COVER	2	PC.
026	2		626596-9	FIELD 115V	1	PC.
027			266257-5	TAPPING SCREW 4X28	4	PC.
028			213048-5	O RING 6	1	PC.
029			256459-1	PIN	1	PC.
030			227514-6	SPIRAL BEVEL GEAR 38	1	PC.
031			213673-2	O RING 52	1	PC.
032			285841-7	BEARING RETAINER	1	PC.
033			211129-9	BALL BEARING 6201DDW	1	PC.
034	2		318302-3	* BEARING BOX	1	PC.
	3		318334-0	* BEARING BOX	1	PC.
035			265490-6	HEX. SOCKET HEAD BOLT M4X16	4	PC.
036			415300-9	LABYRINTH RING	1	PC.
037			324038-4	SPINDLE	1	PC.
038	1		251391-4	* PAN HEAD SCREW M5X16	1	PC.
	2		265180-1	* PAN HEAD SCREW M5X16	1	PC.
042			158518-6	MOTOR HOUSING COMPLETE	1	PC.
		INC.	810341-4	CAUTION LABEL	1	PC.
043			864123-6	NAME PLATE F/9564PCV	1	PC.
044			631788-7	CONTROLLER	1	PC.
046	2		816795-3	INDICATION LABEL	1	PC.
047	1		188365-1	* REAR COVER SET	1	PC.
	2		183U29-8	* REAR COVER SET	1	PC.
048			266048-4	TAPPING SCREW 4X40	3	PC.
049			682566-8	CORD GUARD 10	1	PC.
050			664265-4	CORD WITH PLUG 2P-16-2.5M SJ	1	PC.
051			687169-3	STRAIN RELIEF	1	PC.
052			266192-7	TAPPING SCREW 4X14	1	PC.
053	2		644003-0	BRUSH HOLDER	2	PC.
054			266256-7	TAPPING SCREW PT3X10	4	PC.
055	4		196454-8	A.C. CARBON BRUSH CB-340 2PC/SET (W/ ORIGIN)	1	SET
056	2		651064-3	SWITCH FPB-2114S	1	PC.
057			265954-0	TAPPING SCREW BIND PT3X8	1	PC.
058			345504-8	PLATE	1	PC.

Item No	Type	Ref	Part No	Description	Qty	Unit
059			154584-1	SWITCH LEVER B COMPLETE	1	PC.
061			819356-8	CLEAR LABEL	1	PC.
100			265083-9	+ FLAT HEAD SCREW M8X11 F/HEAD COVER	1	PC.
D01			652044-2	+BIND SCREW M3.5X5.0	2	PC.
D02			654037-5	INSULATED EYE TERMINAL FT1.25-M3	2	PC.
D03			654285-6	RECEPTACLE	2	PC.
D04			654233-5	INSULATED TERMINAL FT1.25M3TOR	2	PC.
<b>ACCESSORIES</b>			<b>- See Catalogue or visit <a href="http://www.makita.ca">www.makita.ca</a> for more accessories -</b>			
A01	2		158237-4	GRIP 36 COMPLETE (RUBBER GRIP)	1	PC.
	Opt.		194514-0	VIBRATION PROOF GRIP F/4" - 6", PKG	1	PC.
A02	2		D-20781	4 1/2" DEPRESSED CENTER WHEEL A24R	1	PC.
	3		A-95956-25	4-1/2" D.C.G.W WA36N 25/PK	1	SET
	Opt.		-----	DEPRESSED CENTER GRINDING WHEELS		
A03			782424-9	LOCK NUT WRENCH 28	1	PC.
A05			417322-5	HEAD COVER (USE ITEM 100 TO SETUP)	1	PC.
A06	1		135107-4	* TOOLLESS WHEEL COVER 115A ASS'Y	1	PC.
		INC.		* Item No. 38		
	2		135635-9	* 4-1/2" TOOLLESS WHEEL COVER ASS'Y (H:46mm)	1	PC.
		INC.		* Item No. 38		
	3		123144-0	* 4-1/2" TOOLLESS WHEEL COVER ASS'Y (H:46mm)	1	PC.
		INC.	213009-5	* O RING 4 (Added)	1	PC.
		INC.		* Item No. 38		
A07			224399-1	INNER FLANGE 45	1	PC.
A08			224568-4	LOCK NUT 5/8-45	1	PC.
A09	1		195236-5	* DUST COLLECTION COVER 4-1/2-5" - See Parts Breakdown #195236-5	1	PC.
	2		196575-6	* DUST COLLECTION COVER 4-1/2-5" - See Parts Breakdown #196575-6	1	PC.
A10			195446-4	DUST COVER SCREEN ATTACHMENT SET	1	PC.
A11	1		122642-1	* CUT-OFF WHEEL GUARD F/4-1/2"	1	PC.
	2		122910-2	* CUT-OFF WHEEL GUARD F/4-1/2"	1	PC.
A12			-----	DIAMOND CUP WHEELS (Use with Item No. A09)		
A13	1		193794-5	* DUST COLLECTION WHEEL COVER 4-1/2", 5"	1	PC.
	2		196845-3	* DUST COLLECTION COVER 5" DMND, TUCKPOINT BLADE	1	PC.
A14			193048-0	SANDING LOCK NUT 5/8-48	1	PC.
A15			743036-3	RUBBER PAD 100	1	PC.

**SERVICE CHANGES**

**1. Changes on Wheel Cover Assembly & Bearing**

(T/I # 80668, A4621)

(TI#B3100)

Item No.	Description	Type 1	Type 2	Type 3
34	Bearing Box	317570-5	318302-3	318334-0
A06	Toolless Wheel Cover	135107-4 (H: 42 mm)	135635-9 (H: 46 mm)	123144-0 (H: 46 mm)
A06 INC.	O Ring 4	----- 213009-5		
38	Pan Head Screw M5X16	251391-4		265180-1
A09 Opt.	Dust Cover Collector Set	195236-5		196575-6
A11 Opt.	Cut-Off Wheel Guard F/4-1/2"	122642-1		122910-2
A13 Opt.	Dust Collection Wheel Cover > Dusct Collection Cover F/Diamond & Tuckpoint Blade	193794-5		196845-3

Type 2 and Type 3 parts are completely interchangeable as a set  
 Imte no. 38 is a component of A06

**Wheel Cover**

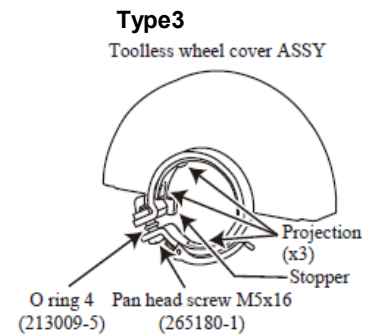
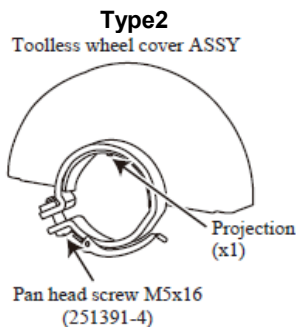

**Bearing Box**

**Type1**

**Type2**

**Type 3**

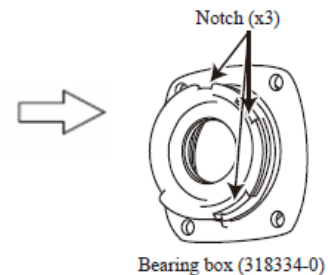
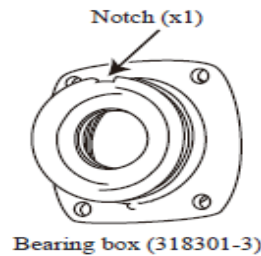
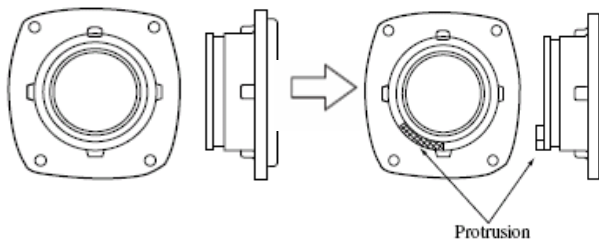

**2. Changes on Rear Cover Set**

(T/I#DB563)

Item No.	Description	Type 1	Type 2
047	REAR COVER SET	188365-1	183U29-8

The current parts in stock can be used until May 2023.

The use of the current parts will be prohibited from June 2023 due to the revised standard.

[1] 9564PCV, 9565PCV, 9566PCV, GD0801C, GD0811C

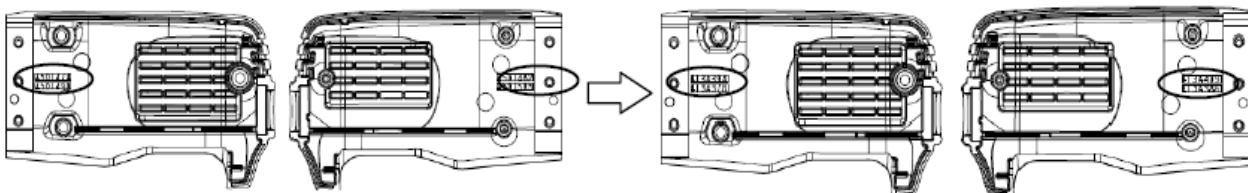

The side thickness of Rear cover will be slightly increased and the molded numbers designated in circles will be changed to distinguish the new from the current.